

**If you upgraded to our Twist2Go system, skip to page 3.**



We've made a handy video version of this fitting guide, just click the play button to view it.

If you prefer to print the instructions or simply to follow step-by-step, just keep reading.

**Before you begin**

The front roller blind is the highest and closest to you, so make sure that when marking the place where you will place the brackets, the rounded part of the bracket is pointing downwards.

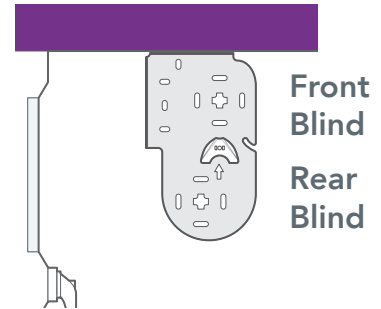

**Fitting the brackets**

**1**

The brackets offer three methods of installation:

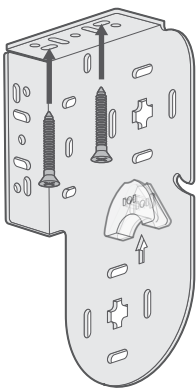

**Top-Fixing**

Where the brackets are screwed into the lintel (or 'ceiling' of the recess)

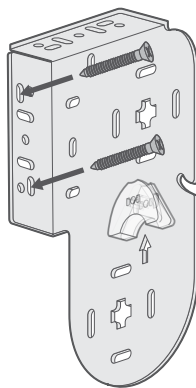

**Face-Fixing**

Where the brackets screw into a facing surface (a wall or window frame)

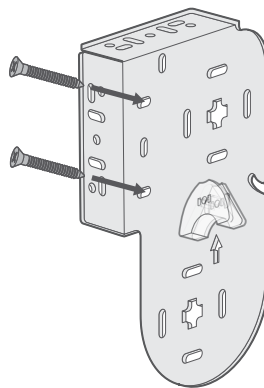

**Side-Fixing**

Where the brackets are screwed into the side walls of the recess

**Top Tip**

Top-fixing or face-fixing are recommended for most installations, whereas **side-fixing is only recommended if the width you gave us was taken right at the top of the recess.**

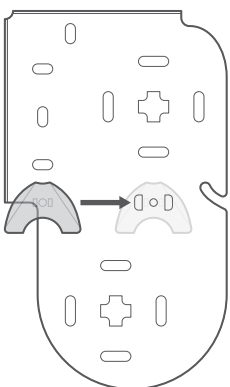

**Control Side (chain control only)**

On the control side, clip the chain runner attachment into the slot in the center of the bracket.

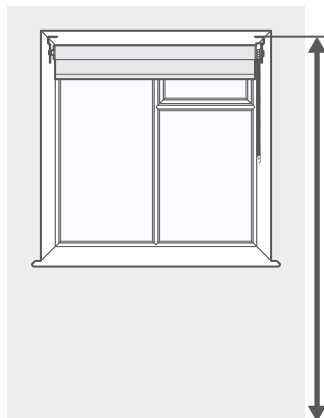

For safety reasons, always ensure that the top of the blind is installed at least 150cm (1500mm) from the floor. This is not applicable to blinds upgraded to SmartView app control.

**Fitting the blind**

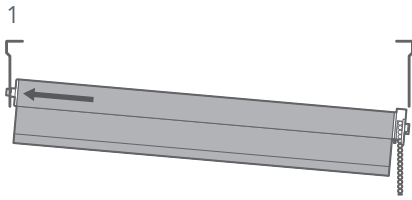

Install the rear blind first. Begin by placing the spring-loaded pin into the lower cross-shaped hole on the bracket. Push the blind toward the bracket so the spring-loaded pin depresses.

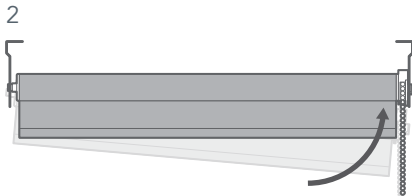

Keeping the pin depressed, lift the control end of the blind upwards so the blind is level and the chain is hanging directly down from the bottom of the sidewinder and slot the pegs of the control into the cross section of the bracket.

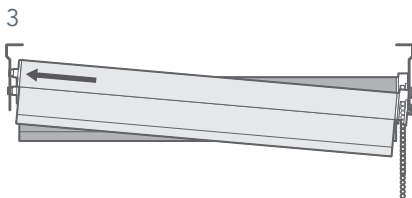

Repeat the process for the front blind, placing the pin into the cross-shaped hole on the bracket and lifting the control side up to slot into the cross section.

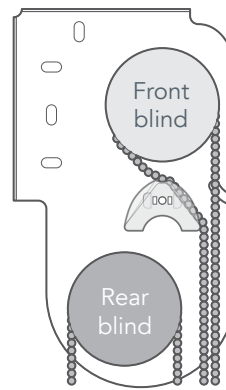
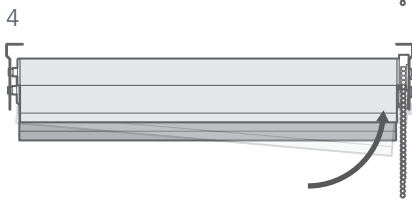

**For Chain Control Blinds:**

Take the chain for the top (front) blind and drape the back part of the chain over the chain runner so that the chain sits forward, preventing it from tangling with the other blind's chain.

## Fitting a Twist2Go Double Roller Blind



We've made a handy video version of this section!

If you prefer to print the instructions or simply to follow step-by-step, just keep reading.

Starting with the sheer blind, insert the blind into the recess at an angle and push the tightener against the wall. Lift the control end of the blind until level and release pressure, the blind will hold itself in place. We recommend fitting the rear blind approximately 50mm down from the top, and in from the front, of the recess.

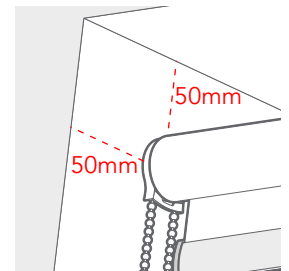
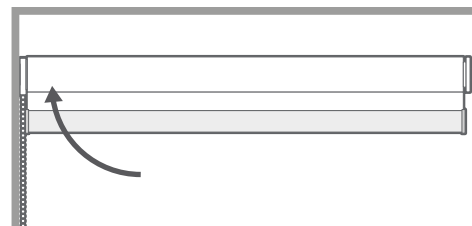
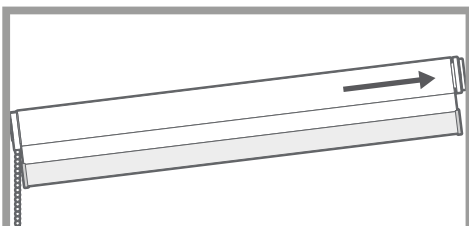

Make adjustments to the position of the blind so that it is straight and level, before locking it in place.

### For smaller blinds:

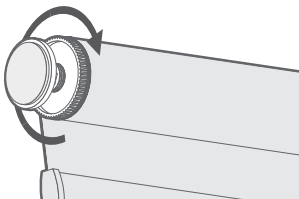

Tightener on the left

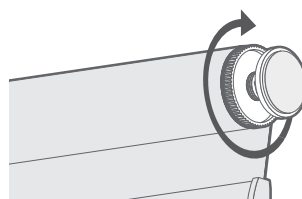

Tightener on the right

Hold the blind securely in place and turn the tightening wheel to tighten the blind in place.

If the tightener is on the left side of the blind turn it towards you. If it's on the right, turn it away from you.

### Top Tip

Make sure that you tighten the wheel as much as you possibly can so that the blind remains secure and does not slip. If you find that the 'foot' of the mechanism that presses against the wall is spinning as you try to tighten, take the blind out of the window, tighten it a little, then push it back into place and try again.

### For larger blinds:

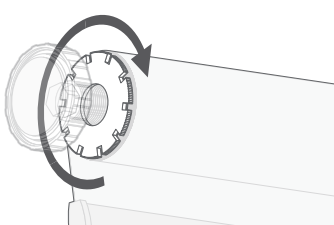

Tightener on the left

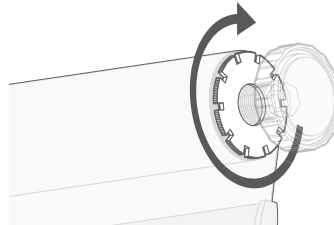

Tightener on the right

Hold the blind securely in place and turn the tightening wheel to tighten the blind in place.

If the tightener is on the left side of the blind turn it towards you. If it's on the right, turn it away from you.

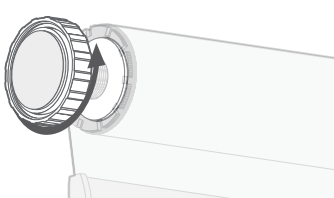

cap on the left

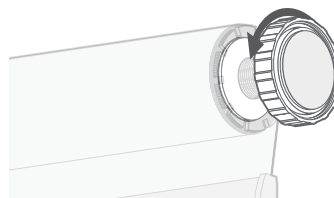

Cap on the right

Once the blind is secured in place, turn the end cap until it locks against the tightening wheel. This will lock the tightening wheel in place.

If the cap is on the left side of the blind turn it away from you. If it's on the right, turn it towards you.

**Child Safety**  
Not applicable for SmartView Roller Blinds

  
**WARNING**

Young children can be strangled by loops in pull cords, chains, tapes and inner cords that operate the product.



To avoid strangulation and entanglement, keep cords out of the reach of young children. Cords may become wrapped around a child's neck.

Move beds, cots and furniture away from window covering cords.

Do not tie cords together. Make sure cords do not twist and create a loop.

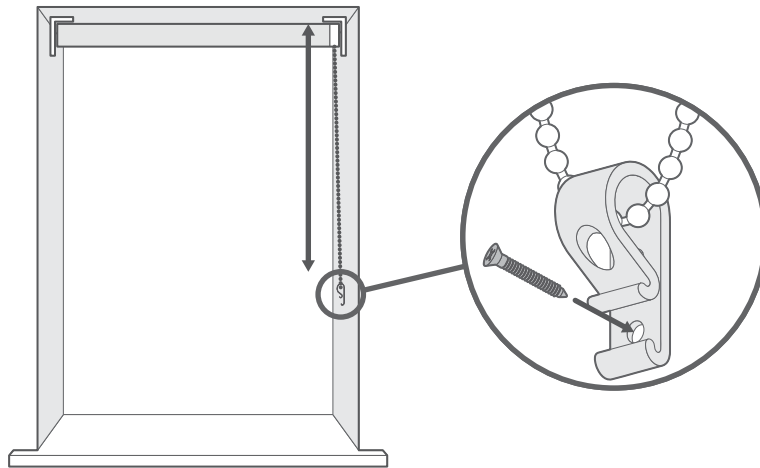

The cord retaining device must be installed at the maximum distance possible from the control mechanism to prevent looped cords from becoming slack.

Place the retaining device on the wall and mark the position of the screw hole(s) with a pencil.

Attach the retaining device to the wall using the fixings provided.

**If you upgraded to SmartView app control**

Once your blinds are installed we recommend plugging in the motor to allow them to fully charge before use. Plug the charging cable (included) into the motor charging port and allow to charge until the LED on the charger plug turns green.

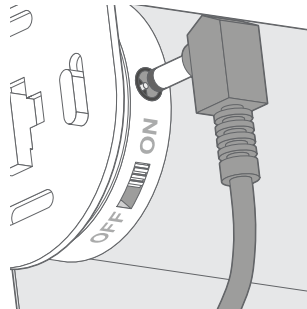

On the front of the swing tag that comes with each blind, you'll find a handy QR code you can scan with your phone. Scan this to download the SmartView app - you'll be setting up your blinds in moments!

**Top Tip**

When scanning your blinds into the app, each blind from a pair will be scanned separately.

You may find it helpful to name your blinds in such a way that it's obvious which blinds are part of which pair.

Recycle your electrical and electronic devices free at your local recycling centre. To find your nearest centre, visit the [Recycle More](#) website and type in your postcode.



Blinds 2go Ltd is part of the DTS scheme.